

Article number: 20497892B1

Description: E+G Flat adjustable tension lever stainless
GN125.5-36-M10-20-D

Measures

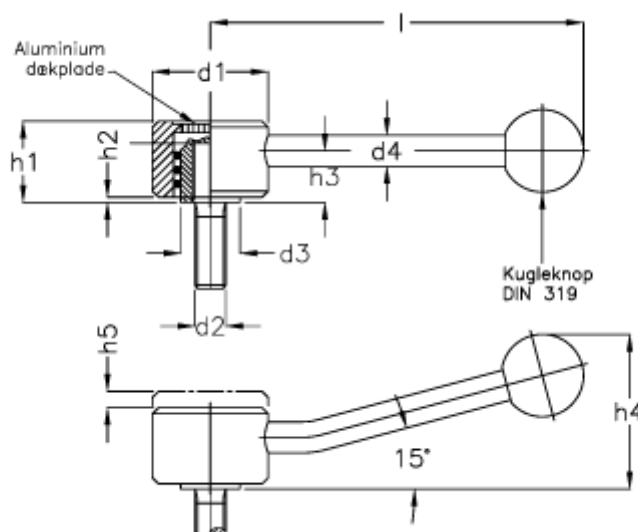

d1 = 36	h5 = 4.5
d2 = M10	l1 = 16
d3 = 16.0	
d4 = 10	
h1 = 24.5	
h2 = 2.0	
h3 = 15.0	
h4 = 45	